



A **valmont**  BRAND

Your Best Source For Quality, Durability, and Innovation



**Marking, Safety, Fencing, Parking, Traffic Control, Noise Abatement
and Installation Products for Parks and Recreational Facilities**



CARSONITE®

A **valmont**  BRAND



Marking and Safety Products for Parks and Recreational Applications

Who we are

With more than 30 years of experience serving highway, utility, and federal recreation markets, Carsonite has developed distinctive products and applications geared to each market. Our posts offer the maximum in durability and flexibility to address vehicle impacts and a variety of soil conditions. Carsonite posts are engineered to enhance visibility, simplify installation, withstand the elements and increase safety.

Our markers and delineators are the industry standard. Many of the marking products in wide use today are based on Carsonite patents. Our trademarked profiles remain the standard by which all other markers are measured, and Carsonite's easily identifiable products are manufactured and assembled in the United States.

Carsonite is committed to excellence. Our name appears on all of our products, and we are dedicated to customer service. Our sales representatives and a vast distribution network stand ready to serve you with quality products and timely delivery.

Table of Contents

Posts and Markers	
Carsonite RoadMarker™ (CRM).....	4
Curv-Flex™ Marker (CFR)	5
Dual-Sided Marker (CIB)	6
Tuff-Flex™ Marker (CTFM)	7
Boundary Marker (CBM)	8
Carsonite Sign Support Post (CSS)	9
Carsonite Support Post (CSP)	10
Gr eenLine™ Single-Curve Marker (CGD)	11
High-Impact Survivor™ (CDS)	12
Campsite Marker (CCSM)	13
The Channelizer™ Surface Mount (SDC)	14
SuperDuck™ Surface Mount (SDR3)	15
Signs & Decals	
Federal Recreation Universal Symbols	16-19
Winter Recreation	18
Water Recreation	18
Accommodations and Services	18
General Recreation	19
Land Recreation	19
Custom & Stock Signs & Decals	20, 21
Traffic Control Signs	22
Parking Signs	23
Handicap Signs	24
Road Closure Signs and Kits	25
Die-cut Letters and Numbers	26, 27
Reflective Sheeting	28
Reflective Sign Support Cover (RSC)	29
Safety Fencing	
Carsonite Flexible Fencing Systems	30, 31
Sound Barriers	
Carsonite AcoustaShield™ Sound Barrier Systems	32-35
Tools & Other Products	
Installation Tools	36
Anchor Barb	37
Notes	38, 39



19845 U.S. Highway 76
Newberry, South Carolina 29108
800-648-7916 · www.carsonite.com

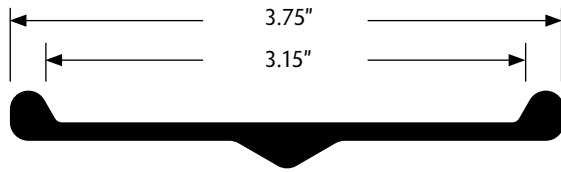

Withstands highway-speed vehicle impacts

The three-rail design of the Carsonite RoadMarker provides both flexibility and structural integrity. Two ribs on the side protect sheeting from vehicle impacts, while the back rib gives added strength for driving into hard soil.

How to Order:

CRM 3

Product number

072

Length (in.)

See chart for availability by color.

Other lengths and colors are available. Contact your representative.

Color (See chart below)

01

Post color	Standard Lengths (in.)
01-White	60, 62, 66, 72, 84
02-Yellow	60, 62, 66, 72
03-Brown	72
04-Orange	60, 62, 66, 72
05-Red	60, 62, 66
07-Green	72
08-Blue	66

Material: Fiberglass Composite, high-performance construction

Options and Accessories: Reflective sheeting
Stock or custom decals
Direct Graphics
Visibility Enhancer
Anchor Barb

Installation tools: Post Driver (PDR, PDRL)
Post Puller
Pilot Hole Driver

Carsonite High Performance RoadMarkers are designed to stand up to nature as well as vehicular impacts, controlled ditch burns, and even small arms gunfire.



Curv-Flex™ Marker

CFR

Drivable, flexible, impact resistant marker

Our most flexible fiberglass composite marker. The Curv-Flex is recommended for areas where vehicle impacts are likely. With its trademarked curve and flange profile, the Curv-Flex marker withstands direct tire impacts. In dense soil conditions, the Curv-Flex may require a small pilot hole before installation.

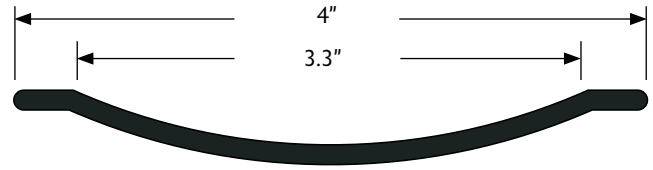

How to Order:

CFR4

Product number

062

Length (in.)

See chart for availability by color.

01

Color (See chart below)

Post color	Standard Lengths (in.)
01-White	27, 60, 62, 66

Other lengths and colors are available. Contact your representative.

Material: **Fiberglass Composite**

- Options and Accessories: Reflective sheeting
 Stock or custom decals
 Anchor Barb
- Installation tools: Post Driver (PDR, PDRL)
 Post Puller
 Pilot Hole Driver
 Guide Tube



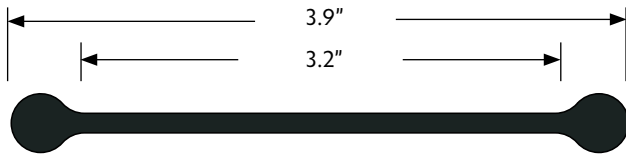

Durable, attractive two-sided marker

This durable fiberglass composite Carsonite Dual Sided Marker accepts sheeting or decals on both sides. It is ideal for 180-degree messages—for rural route marking or for 9-1-1 identification. The marker rebounds after impacts, and resists vandalism. The raised, reinforced ribs along each side help prevent scratching or removal of the legends if impacted.

How to Order:

Color (See chart below)

CIB3 Product number

066 Length (in.)
See chart for availability by color.

Post color	Standard Lengths (in.)
01-White	60, 62, 66
03-Brown	60, 62, 66, 72

01

Other lengths and colors are available. Contact your representative.

Material: Fiberglass Composite

- Options and Accessories:**
- Reflective sheeting
 - Stock or custom decals
 - Direct Graphics
 - Visibility Enhancer
 - Anchor Barb

- Installation tools:**
- Post Driver (PDR, PDRL)
 - Post Puller
 - Pilot Hole Driver



Tuff-Flex™ Marker

CTFM

Designed for two-sided messages and hard soils This

fiberglass composite marker offers all of the benefits of the Dual Sided Marker, with additional rigidity. With its thickened center rib, it remains drivable in virtually any soil condition. Excellent for 180-degree visibility.

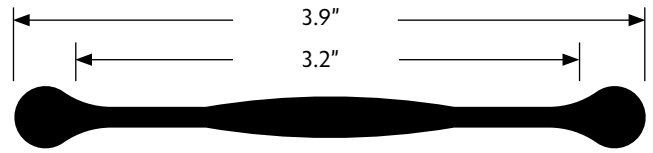

How to Order:

CTFM
Product number

060
Length (in.)
See chart for availability by color.

Color (See chart below)

05

Post color	Standard Lengths (in.)
02–Yellow	60, 62, 66, 72
04–Orange	60, 62, 66, 72
05–Red	60, 62, 66, 72
08–Blue	60, 62, 66, 72

Other lengths and colors are available. Contact your representative.

Material: Fiberglass Composite

- Options and Accessories:** Reflective sheeting
Stock or custom decals
Visibility Enhancer
Anchor Barb
- Installation tools:** Post Driver (PDR, PDRL)
Post Puller
Pilot Hole Driver



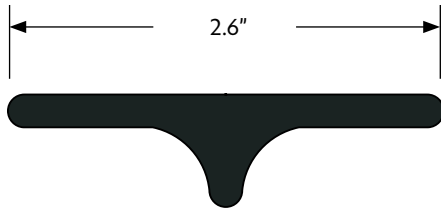

Excellent for pedestals and enclosures

The Carsonite Boundary Marker post is a rigid composite post that can be driven in virtually any soil conditions. When cost is a concern, this economical marker is an ideal solution.

How to Order:

CBM 2
Product number

062
Length (in.)
See chart for availability by color.

Color (See chart below)

04

Color	Standard Lengths (in.)
04-Orange	48, 60, 62, 66, 72

Other lengths and colors are available. Contact your representative.

- Material:** Fiberglass Composite
- Options and Accessories:** Stock or custom decals
Reflective sheeting
- Installation tools:** Post Driver (D250)
Post Puller
Pilot Hole Driver



Sign Support Post

Great Looks and Maximum Durability

This composite post is specifically designed for use with Carsonite's composite signs up to 12" x 36". When ordered with Carsonite signs, the post can be ordered pre-drilled for ease of installation.



How to Order:

Color (See chart below)

CSS3 Product number

072 Length (in.)
See chart for availability by color.

01

Color	Standard Lengths (in.)
01-White	72, 84, 96
03-Brown	72, 84, 96

Other lengths and colors are available. Contact your representative.

- Material:** Fiberglass Composite
- Options and Accessories:** Reflective sheeting
Stock or custom signs
- Installation tools:** Post Driver (PDR, PDRL)
Post Puller
Pilot Hole Driver



Support Post

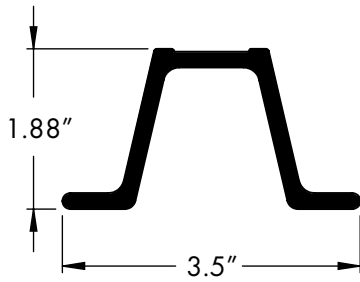

How to Order:

CSP **72** **07**
 Product number Length (In.) Color (3 choices)

Length	Color
072-72"	03-Brown
096-96"	07-Green
120-120"	09-Gray
144-144"	



Material: Fiberglass Reinforced Composite

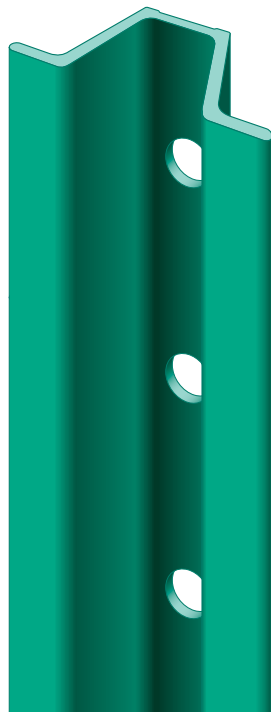

Durable, and easy installation

The Carsonite Support Post (CSP) is a U-channel shaped sign posts meeting the dimensions of a standard 3 lb U-channel. This post is intended for use as an object marker and a sign posts in applications requiring long-term outdoor durability, vandal resistance, and easy installation.



GreenLine™ Single-Curve Marker

CGD

Highly flexible and available in bright colors

The GreenLine Single-Curve Marker is a highly flexible post featuring a simple, curved design that will take direct tire impacts at highway speeds. Available in bright colors, this attractive marker is ideal for 9-1-1 and yard marker applications. Decals or reflective sheeting can be applied to both sides. For hard soils, a convenient metal U-channel anchor may be added.

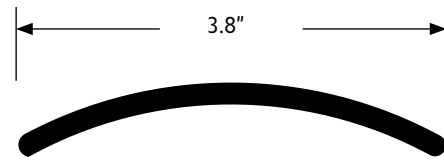

How to Order:

CGD

Product number

1

1=plain
U=U-channel
option
Note: U-channel posts' overall length are 12" longer

060

Length (in.)
See chart for availability by color.

Color
(See chart below)

01

Color	Standard Lengths (in.)
01-White	60, 66
02-Yellow	60, 66

Add U for optional U-channel

U

Other lengths and colors are available. Contact your representative.

Material:

Polycarbonate

Options and Accessories:

- Reflective sheeting
- Stock or custom decals
- Anchor Barb

Installation tools:

- Post Driver (PDR, PDRL)
- Guide Tube
- Post Puller
- Pilot Hole Driver
- U-channel Driver



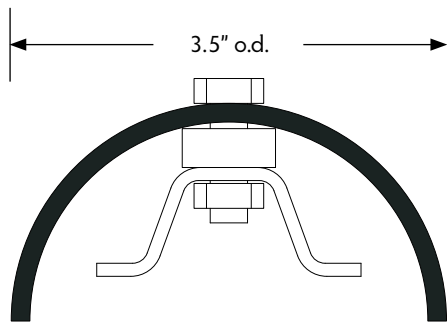

High-performance marker for high-impact areas

One of Carsonite's most durable posts. This polymer post with integral metal U-channel is easily driven into all types of soils. For use in areas where impacts are likely, this post has been impact tested at speeds of 65 mph.

How to Order:

CDS 3
Product number

066
Length (in.)
See chart for availability by color.

Color (See chart below)
01

Color	Standard Lengths (in.)
01-White	66
02-Yellow	66
09-Gray	66

Other lengths and colors are available. Contact your representative.

- Material:** Polypropylene
- Options and Accessories:** Reflective sheeting
Stock or custom decals
- Installation tools:** U-channel Driver (D300)

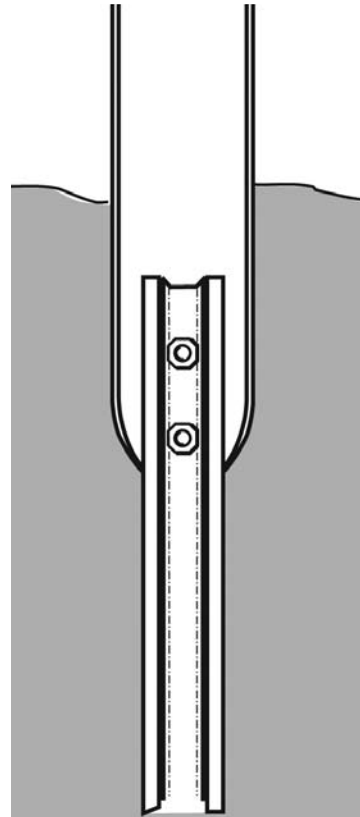

Campsite Marker

CCSM

Low-cost, dual-sided for campsites, picnic areas, etc.

For high visibility and easy identification, the Carsonite Campsite Marker is the perfect choice. This three-rail design combines structural integrity with above-ground flexibility, as well as protection for decals.

The marker is also highly resistant to vandalism. Anchors (sold separately) make it virtually impossible to remove the markers without proper equipment.

The reflective site identification decal is included. Custom decals are available, and can be applied to the metal slider—up to 6" long. Add your logo, name or any message. Carsonite will apply decals at our factory to save you time and money.

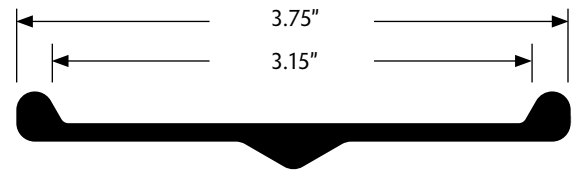

How to Order:

CCSM 3

Product number

066

Length (in.)

See chart for availability by color.

Color (See chart below)

01

Post color	Standard Lengths (in.)
01-White	66, 72
03-Brown	66, 72

Other lengths and colors are available. Contact your representative.

Material: Fiberglass Composite post
Metal slide

Options and Accessories: Reflective sheeting
Stock or custom decals
Direct Graphics
Anchor Barb

Installation tools: Post Driver (PDR, PDRL)
Post Puller
Pilot Hole Driver



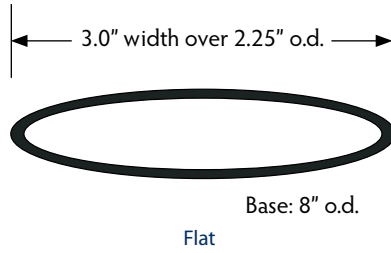
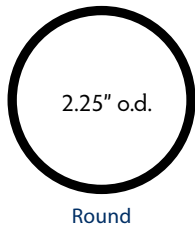

Surface mounted, impact-resistant delineator

Carsonite's 2.25" Channelizer provides excellent delineation for high-traffic areas. The top of the post may be round for bands of reflective sheeting or flattened to support strips of sheeting up to 3" wide. Great for parking lots.

How to Order:

Round-2
Flattened-F

SDC **2** **036**

Product number Length (in.)

See chart for availability by color.

Color (See chart below)

Color	Standard Lengths (in.)
01-White	36, 42
02-Yellow	36, 42
04-Orange	36, 42

Other lengths and colors are available. Contact your representative.

- Material:** Polypropylene
- Base:** Natural Rubber
- Options and Accessories:** Reflective sheeting
Stock or custom decals
Mastic Pad

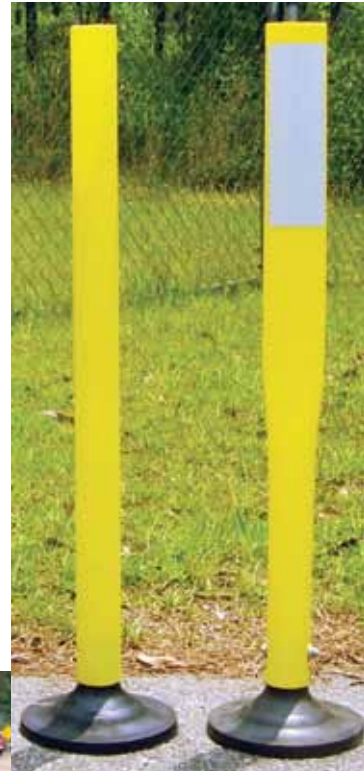

Super Duck™

SDR3

Surface-mounted, Impact-resistant Delineator

This unique 3" channelizer supports up to 6 bands of reflective sheeting. Ideal for construction sites, lane changes, and adding visibility to raised medians.

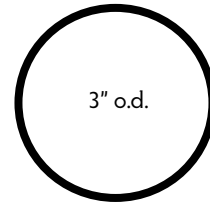

Base: 8" o.d.



How to Order:

SDR3

Product number

036

Length (in.)

Color
(See chart below)

01

Color	Standard Lengths (in.)
01-White	36
02-Yellow	36
04-Orange	36

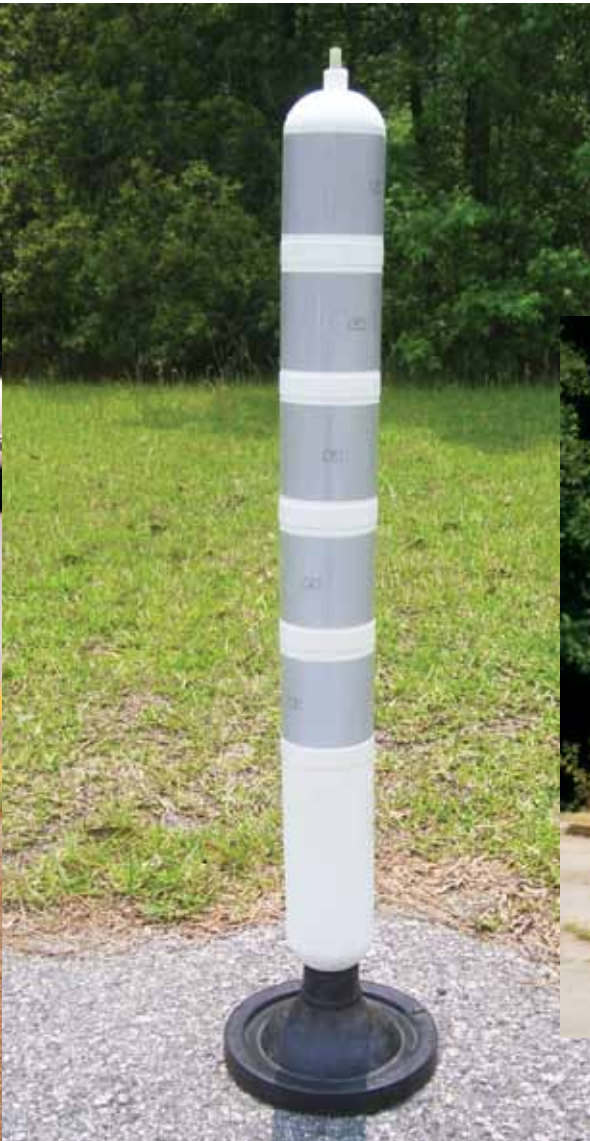

Material:

Polypropylene

Base: Rubber

Options and Accessories:

Reflective sheeting

Stock or custom decals

Mastic Pad



Federal Recreation Signing (Universal Symbols)



Stock or Custom Made

Carsonite offers a complete line of outdoor quality signs and decals featuring universally recognized federal symbols for recreation. These signs and decals can be combined with a Carsonite marker to create a highly cost-effective, low-maintenance signing system. All signs and decals can be customized for your needs.

3" x 3" recreational symbols are available in 8½" x 11" pages containing six symbols and three directional arrows. All recreational symbols are printed with a white engineering-grade reflective background with brown copy. Custom colors are available. Add a red slash to any recreational symbol to prohibit the activity.

Recreational symbols can also be ordered as 8" x 8" or 12" x 12" signs. See illustration below.



Fed Rec 3" x 3" symbols in convenient binder pages



Fed Rec 12" X 12" Sign



Fed Rec 8" X 8" Sign



RSS034
Parking



Add a red slash to any graphic to prohibit the activity.
Add "SL" to the product number.
For example: RSS034SL
NO Parking

ILLUSTRATIONS ARE NOT TO SCALE

FACILITY SYMBOLS

 RSS034 Parking	 RSS035 Showers	 RSS036 Viewing Area	 RSS037 Sleeping Shelter	 RSS038 Campground	 RSS039 Picnic Shelter
 RSS040 Trailer Sites	 RSS041 Trailer Sanitary Station	 RSS042 Campfires	 RSS043 Trailer Shelter	 RSS044 Picnic Area	 RSS045 Kennel
 RSS085 Laundry	 RSS306 Electrical Hookup	 RSS307 Motorhome	 RSS308 Group Camping	 RSS309 Group Picnicking	

DIRECTION SYMBOLS























 RSS100 Directional Arrows	 RSS101 Left Arrow	 RSS102 Right Arrow	 RSS103 Arrow Head	 RSS327 Arrow	 RSS340 Directional Arrow
--	---	--	---	--	--

WINTER RECREATION

 RSS046 Cross-Country Skiing	 RSS047 Downhill Skiing	 RSS048 Ski Jumping	 RSS050 Ice Skating	 RSS051 Ski Bobbing	 RSS052 Snowmobiling
 RSS077 Winter Recreation Area	 RSS078 Snowshoeing	 RSS317 Sledding	 RSS318 Chairlift	 RSS319 Snow Tubing	 RSS320 Snowboarding
 RSS607 Mushing					

ILLUSTRATIONS ARE NOT TO SCALE

WATER RECREATION

 RSS053 Marina	 RSS054 Launching Ramp	 RSS055 Motorboating	 RSS056 Sailboating	 RSS057 Rowboating	 RSS058 Water Skiing
 RSS059 Surfing	 RSS061 Swimming	 RSS062 Diving	 RSS063 Fishing	 RSS079 Canoeing	 RSS087 Boat Tours
 RSS088 Wading	 RSS107 Whitewater Rafting	 RSS303 Seaplane	 RSS321 Scuba Diving	 RSS322 Fishing Pier	 RSS323 Personal Watercraft
 RSS324 Kayak	 RSS325 Raft	 RSS326 Wind Surf			

ACCOMMODATIONS/SERVICES

 RSS018 Lodging	 RSS019 Food Service	 RSS020 Grocery Store	 RSS021 Men's Restroom	 RSS022 Restrooms	 RSS023 Women's Restroom
 RSS024 First Aid	 RSS025 Telephone	 RSS026 Post Office	 RSS027 Mechanic	 RSS028 Handicapped	 RSS029 Airport
 RSS031 Bus Stop	 RSS032 Gas Station	 RSS033 Vehicle Ferry	 RSS310 Elevator	 RSS311 Family Restroom	 RSS312 Helicopter

All designs are available as 3" x 3" Decal Pages, 8" x 8" and 12" x 12" Signs

GENERAL RECREATION



RSS001 Firearms
 RSS002 Smoking
 RSS003 Automobiles
 RSS004 Trucks
 RSS005 Tunnel
 RSS006 Lookout Tower



RSS007 Lighthouse
 RSS008 Falling Rock
 RSS009 Dam
 RSS010 Fish Hatchery
 RSS011 Deer Viewing Area
 RSS012 Bear Viewing Area



RSS013 Drinking Water
 RSS014 Information
 RSS015 Ranger Station
 RSS016 Pedestrian Crossing
 RSS017 Pets On Leash
 RSS076 Environmental Study Area



RSS080 Point Of Interest
 RSS086 Litter Container
 RSS208 Firewood Cutting
 RSS301 Natural Study Area
 RSS302 Pickup Truck
 RSS304 Cultural Interest



RSS305 Alcohol Permitted
 RSS305SL No Alcohol
 RSS331SL No Alcohol 3x3
 RSS330SL No Fireworks 3x3

ILLUSTRATIONS ARE NOT TO SCALE



LAND RECREATION



RSS064 Horse Trail
 RSS065 Trail Bike Trail
 RSS066 Bicycle Trail
 RSS067 Recreational Vehicle Trail
 RSS068 Hiking Trail
 RSS069 Playground



RSS070 Amphitheater
 RSS071 Tramway
 RSS072 Hunting
 RSS073 Stable
 RSS074 Interpretive Trail
 RSS075 Interpretive Auto Trail



RSS081 Climbing
 RSS082 Technical Rock Climbing
 RSS083 Rock Collecting
 RSS084 Spelunking
 RSS105 Jogging
 RSS108 ATV



RSS200 ONLY
 RSS313 Tramway
 RSS314 Corral
 RSS315 Hang Glider
 RSS109 Archer
 RSS110 Mile



RSS316 Rollerblading
 RSS802 Trail Courtesy
 RSS328 Bicycle Lane
 RSS098 Skateboarding



AGENCY LOGOS



RSS104 Forest Service Shield
 RSS201 Bureau Of Land Management
 RSS202 National Park Service
 RSS203 Corps of Engineers
 RSS204 Department Of Interior
 RSS205 Fish & Wildlife Service

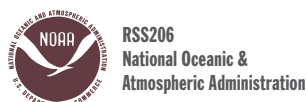

RSS206 National Oceanic & Atmospheric Administration
 RSS207 Bureau Of Indian Affairs

All agency logos are available. Contact your representative.

Custom Signs and Decals

Recreation Products



ILLUSTRATIONS ARE NOT TO SCALE

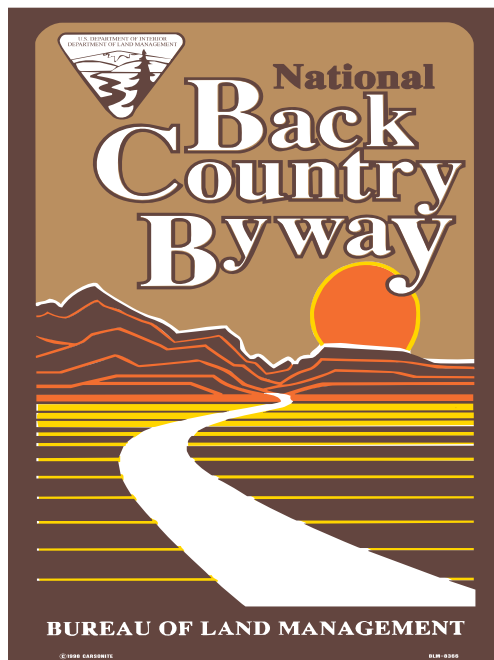

Stock Decals, can be personalized



8621TL
Closed to Vehicles Wider...
12x12



808BFC
Private Property
2 7/8x10 1/4



499EMR
Invaluit
Boundary
2 3/8x15



283FPB
Boundary



257FWR
Survey Marker
2 3/8x11 1/4



110SM
Survey Marker
2 3/8x8 1/2



139PB
Property
Boundary
2 3/8 x 10



378E
Easiest
3x4



373MD
Most Difficult
3x4



374MD
More Difficult
3x4



300NH
No Hunting
2 7/8x14 1/2



250R
Reserved
2 7/8x12



337DNE
Do Not Enter
2 7/8x13 3/4



252V
Visitors
2 7/8x12



251HC
Handicapped
Only
2 7/8x20 1/2



321R
Registration
2 7/8x16



917LNF
Trail Exit
2 7/8x15



916ENF
Trail Entrance
2 7/8x15



394TRMR
(Diamond)
3x5



394TRIMW
(Diamond)
3x5



394TRMBLK
(Diamond)
3x5



394TRIMG
(Diamond)
3x5



979MPH
5 Miles Per Hour
2 7/8x5 1/2



394TRIMY
Symbol
3x5



394TRMO
(Diamond)
3x5



394TRMBL
(Diamond)
3x5

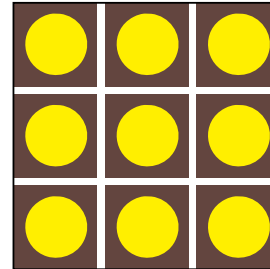
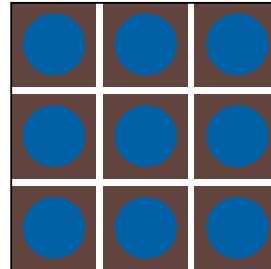
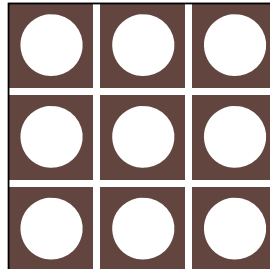
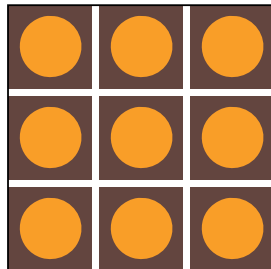
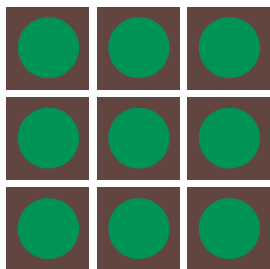

Discs (3x3)
Sheets of 9 discs per color, white,
blue, orange, green or yellow on a
brown background



249FL
Fire Lane
2 7/7x12



1215FL Fire
Lane
2 7/8x13 1/2



317NP
No Parking
2 7/7x13 1/8



600CL
Closed
2 7/8x16



535ORV
Off Road
Vehicles
3x9



535SLORV
No Off Road
Vehicles
3x9



798CP
Customer
Parking
2 7/8x13 7/8



601RTR
Route
2 7/8x14



602RTB
Route
2 7/8x14



832MO
No Motor
Vehicles
2 7/8x12 1/2

White: 1007DW
Blue: 1007DB
Orange: 1007DO
Green: 1007DG
Yellow: 1007DY

ILLUSTRATIONS ARE NOT TO SCALE

Traffic Control Signs and Decals



9238PS
Do Not Enter
18x18



9239PS
(No Left)
18x18



9240PS
(No Right)
18x18



9242PS
(No Truck)
18x18



9243PS
(Symbol)
18x18



9244PS
Slow
18x18



9245PS
Bump
18x18



9246PS
Caution
18x18



9247PS
Exit (Right)
18x18



9248PS
Exit (Left)
18x18



9250PS
Exit Only...
12x18



9249PS
Exit Only
18x18



9252PS
Enter Only
18x18



9258PS
Enter (Right)
18x18



9259PS
Enter (Left)
18x18

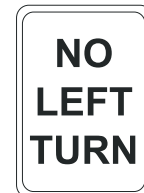

9253PS
No Left Turn
12x18



9260PS
Keep Right
12x18

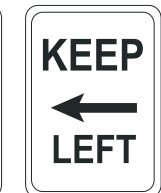

9261PS
Keep Left
12x18



9262PS
One Way (Right)
18x18



9263PS
One Way (Left)
18x18



9254PS
No Right Turn
12x18

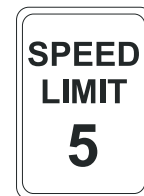

9256PS
Speed Limit 5
12x18



9255PS
Speed Limit 20
12x18



9257PS
Speed Limit 10
12x18



8448STOP
Stop
18x18



9251PS
Employee Entrance
12x18



9264PS
One Way (Arrow Right)
18x6



9265PS
One Way (Arrow Left)
18x6

ILLUSTRATIONS ARE NOT TO SCALE

Parking Signs



**NO
PARKING**

9186PS
No Parking
12x18



**NO PARKING
ANY TIME**

9187PS
...Any Time
12x18



**NO PARKING
FIRE LANE**

9188PS
...Fire Lane
12x18



**NO
PARKING
FIRE LANE**

9189PS
...Fire Lane
12x18



**NO
PARKING
BETWEEN
SIGNS**

9190PS
...Between Signs
12x18



**NO
PARKING
BETWEEN
SIGNS**

9191PS
...Between Signs
12x18



**NO
PARKING
ANY TIME**

9192PS
...Any Time
12x18



**NO
PARKING
ANY TIME**

9193PS
...Any Time
12x18



**NO
PARKING
THIS
SIDE**

9194PS
...This Side
12x18



**NO
PARKING
FIRE
LANE**

9195PS
...Fire Lane
12x18



**NO
PARKING
LOADING
ZONE**

9196PS
...Loading Zone
12x18



**NO
TRUCK
PARKING**

9197PS
No Truck Parking
12x18



**NO
PARKING
TOW
AWAY
ZONE**

9203PS
...Tow Away Zone
12x18



**NO
PARKING
PRIVATE
DRIVE**

9204PS
...Private Drive
12x18



**2 HR
PARKING
VISITOR
PARKING
ONLY**

9200PS
2 Hr Parking Visitor
12x18



**1 HR
PARKING
VISITOR
PARKING
ONLY**

9201PS
1 Hr Parking Visitor
12x18



**NO
PARKING
BEYOND
THIS
SIGN**

9202PS
...Beyond This Sign
12x18



**1 HR
PARKING
CUSTOMERS
ONLY**

9205PS
1 Hr / Customers
12x18



**CUSTOMER
PARKING
ONLY**

9209PS
Customer Only
12x18



**EMPLOYEE
PARKING
ONLY**

9210PS
Employee Parking
12x18



**TENANT
PARKING
ONLY**

9211PS
Tenant Parking
12x18



**VISITOR
PARKING
ONLY**

9212PS
Visitor Parking
12x18



**VISITOR
PARKING**

9213PS
Visitor (Right)
12x18



**VISITOR
PARKING**

9214PS
Visitor (Left)
12x18



**VISITOR
PARKING**

9218PS
Visitor (Arrows)
12x18



**TOW-AWAY
ZONE**

9198PS
Tow-Away Zone
12x6



FIRE LANE

9199PS
Fire Lane
12x6

Stock and custom signs are available for any use.



**EMPLOYEE
PARKING**

9215PS
Employee Parking
12x18



**EMPLOYEE
PARKING**

9216PS
Employee (Arrows)
12x18



**CUSTOMER
PARKING**

9217PS
Customer (Arrows)
12x18



**15
MINUTE
PARKING**

9219PS
15 Minute Parking
12x18



**30
MINUTE
PARKING**

9220PS
30 Minute Parking
12x18



**ONE
HOUR
PARKING**

9221PS
One Hour Parking
12x18



9241PS
(No Parking)
18x18



8620CR
(Symbol)
18x18



**WRONG
WAY**

9207PS
Wrong Way
12x9



**DO NOT
ENTER**

9208PS
Do Not Enter...
12x21



**DO NOT
ENTER**

9206PS
Do Not Enter
12x12



Handicap access signs

Recreation Products



9222PS
Handicapped Parking
12x18



9223PS
Disabled Parking
12x18



9224PS
(Symbol)
12x18



9225PS
Reserved Parking
12x18



9226PS
Reserved Parking
(Arrow Left)
12x18



9227PS
Reserved Parking
(Arrow Right)
12x18



9228PS
Reserved Parking (Arrows)
12x18



9229PS
Parking By Permit Only
12x18



9230PS
Reserved Parking
Permit Required
12x18



9231PS
Van Accessible
12x18



9232PS
(Symbol)
12x12



9233PS
Reserved Parking
Permit Required
12x18



9234PS
Unauthorized Vehicles...
18x12



9235PS
Van Accessible
12x6



9236PS
Permit Required
12x6



9237PS
Violators Will Be Fined
12x6

Road Closure Signs and Kits

These durable, highly visible, composite signs attach to gates, fencing, or posts to easily close roads, temporarily or permanently. Posts sold separately. Add Hazard Marker Signs, Object Markers, and Reflective Sheeting around the area as needed for safety.

Road Closure Kits

Our Standard Road Closure Kit offers a choice of two styles of larger, 15"x30" "Road Closed" signs: with or without a message area that accommodates an explanation decal. The LowVolume Road Closure Kit features a smaller, 10"x20" "Road Closed" sign with a message area. For both, our standard message inserts are listed on Page 28. Custom decals are also available.



8607RC
Road Closure
(without message area)
18x30

Standard Road Closure Kit

RCSTKIT

- (2) Type II Object Marker Signs – **8301YS**
- (1) Hazard Sign with Right to Left Stripes 12"x36" – **8311HM**
- (1) Hazard Sign with Left to Right Stripes 12"x36" – **8310HM**
- (1) Road Closed Sign, choice of:

8607RC "Road Closed" without message area

OR

8608RC "Road Closed" with message area (message decal sold separately, see page 32)

Low-Volume Road Closure Kit

RCLVKIT

- (2) Type II Object Marker Signs – **8301YS**
- (1) Hazard Sign with Right to Left Stripes 8"x24" – **8302HM**
- (1) Hazard Sign with Left to Right Stripes 8"x24" – **8303HM**
- (1) Road Closed Sign 10"x20" with message area – **8608RC**

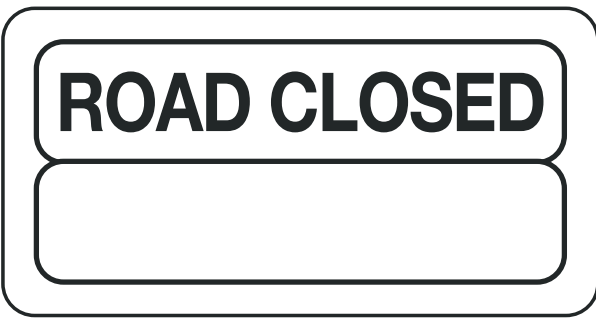

8608RC
Road Closure
(with message area)
15x30

RC-8608LV
Road Closure
(with message area)
10x20



8728RCA
Road Closed Ahead
12x12



8706RC
Road Closed
12x12



Colors:

Road Closure Kits: Red/White

Decals, Letters and Numbers

Carsonite's graphics department manufactures decals to order using a highly specialized, state of the art process that results in tough, UV-resistant decals that stand up to harsh outdoor environments. Our decals start with top quality vinyl or reflective pressure sensitive material. We then use outdoor quality, UV-resistant materials and pigments to put your message on the decal. The process is completed by embedding the graphics under a protective laminate called UV Shield™, which provides resistance to weather, graffiti, vandalism, and fading.

Carsonite offers complete production services to make your message clear, visible, and customized to your needs. Our processes yield unsurpassed weatherability, durability and UV resistance. We are the experts in visibility!



We use state-of-the-art equipment throughout the process to ensure a quality job that meets your specifications and imposes as few limitations as possible to your creativity. Your corporate, park, DOT, or other logos can be faithfully reproduced.

LETTERS AND NUMERALS

These outdoor-quality, ready-made alphabets and numeral sets meet the Federal Highway Administration's specifications. You can apply them to identify equipment, to enumerate sites, and to specify mileage, route numbers, dates and times on signs and decals. Available non-reflective or reflective in 1" to 4" height, any color and any character, including accented characters.



Available products:

- Individual Decals: stock or custom
- Die-Cut Decal sheets: 8½"x11" sheets containing 1", 2", 3" or 4" numerals or letters.
- Die-Cut Decal sheets, 8½"x11" sheets containing 2" or 4" arrows
- Die-Cut Decal sheets, 8½"x11" sheets containing 1", 3/8", 1/2" or 5/16" decimals
- Travel Management System Components for easy-to-assemble specialized decals
- Kits of Letters and Numerals



Decals, Letters and Numbers

Die-Cut Numerals & Alphabets

Available in a variety of colors to suit any need, Carsonite's die-cut numerals and alphabets come in convenient sheets suitable for storage in standard three-hole binders. They are available in reflective or non-reflective self-adhesive material, and in sheets of 1", 2", 3" or 4" letters or numerals.

Reflective or non-reflective letters and numerals are also supplied in white or any color on a solid color background (specify colors). The sizes are 1", 2", 3" and 4".

Symbols per sheet:

- 1" solid or 1" die-cut: 70
- 2" solid or 2" die-cut: 28
- 3" solid or 3" die-cut: 6
- 4" solid or 4" die-cut: 5

Other sizes and designs, decimal points and arrows, as well as kits of letters and numerals are also available. Custom symbols and logos can also be accommodated. Contact your representative.

Colors Available
01-White
02-Yellow
03-Brown
04-Orange
05-Red
06-Black
07-Green
08-Blue

How to Order:

Die-Cut Letters or Numerals:

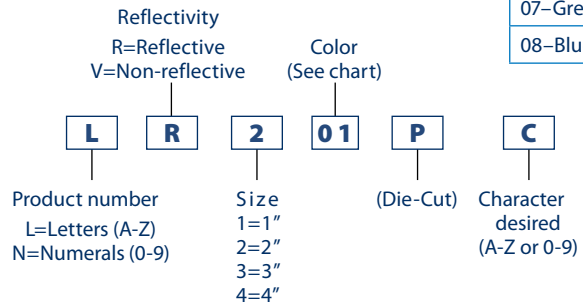

Solid-Color Background Letters or Numerals:

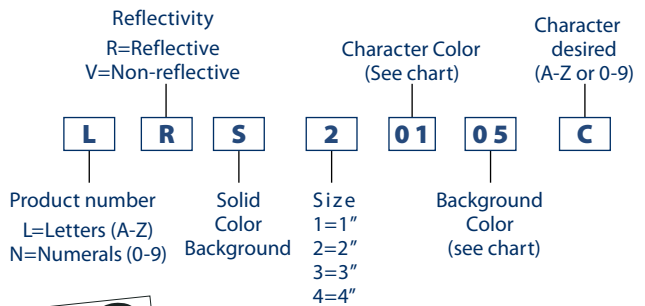

Reflective Sheeting

How to Order:

ENGINEER GRADE 3"

RSE30

Product number

12

Length (in.)

See chart for availability by color.

Other lengths and colors are available. Contact your representative.

Color (See chart below)

04

Color
01-White
02-Yellow
04-Orange
05-Red
06-Black
08-Blue

HI-INTENSITY 3"

RSH30

Product number

12

Length (in.)

See chart for availability by color.

Other lengths and colors are available. Contact your representative.

Color (See chart below)

10

Color
01-White
02-Yellow
05-Red
07-Green
08-Blue
10-Fluorescent Yellow/Green

DIAMOND 3"

RSD30

Product number

06

Length (in.)

See chart for availability by color.

Other lengths and colors are available. Contact your representative.

Color (See chart below)

10

Color
01-White
02-Yellow
05-Red
07-Green
08-Blue
10-Fluorescent Yellow/Green

Enhance Visibility

Carsonite offers a full array of reflective media that can be permanently applied to your posts at the factory or shipped separately. Standard widths are 3.0"; but others are available on special order—contact your representative.

Reflective Sheeting is available in three grades:

- Engineer Grade (RSE30) Type I
- Hi Intensity (RSH30) Type III/IV
- Diamond Grade (RSD30) Type VIII



Material: Vinyl or Reflective Media
 Options and Accessories: Flat or Round Markers
 Visibility Enhancers

Number/Letter Kits also available

Reflective Sign Support Cover

RSC

Surface mounted, impact-resistant delineator

Carsonite's Reflective Sign Support Cover adds visibility to signs. Available in high-intensity or diamond grade reflectivity, these covers attach easily to metal or wooden posts for heightened day or night visibility—safety you can't miss.

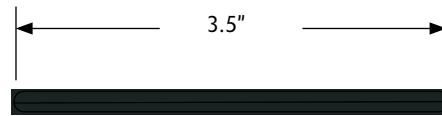

How to Order:

RSC	048	02	RSD	01
Product number	Length (in.) See chart for availability by color.	Color	Grade Hi-Intensity-RSH Diamond-RSD	Sheeting Color (see 2nd chart below)

Color	Standard Lengths (in.)
01-White	48, 60, 72

Sheeting Color
01-White
02-Yellow
05-Red
08-Blue
10-Fluorescent Yellow Green

Other lengths and colors are available. Contact your representative.

Material: Polycarbonate
 Options and Accessories: Stock or custom decals
Mounting Hardware



Recreation Products

Flexible Safety Fencing

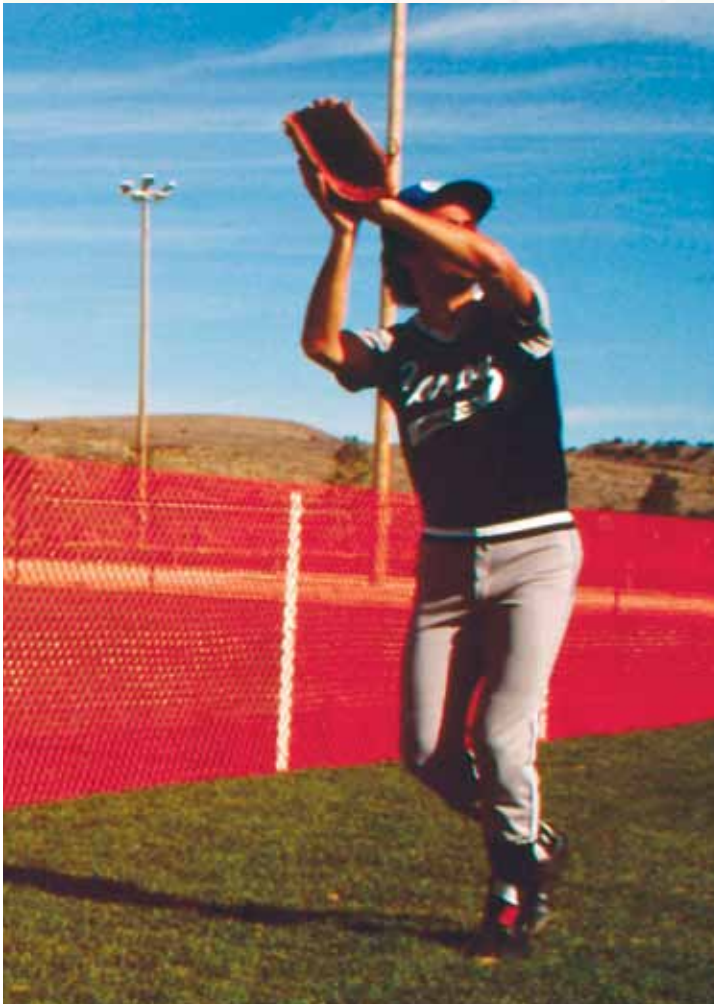

TuffNet Mesh Flexible Fencing

Orange (04), Red (05), Blue (08), Hunter Green (25)

4'x50'	FMF048050	__
4'x100'	FMF048100	__
4'x150'	FMF048150	__



TuffNet Mesh is made from tear-resistant, knitted polypropylene in vibrant colors. Suitable for youth or adult sports.

Carsonite Original Post

White (01). Includes safety cap, tension strap, and drive tip.
66" **CRFP06601**

Flex-Rod Post

White (01). Includes safety cap, and tension strap.
66" **1-FR-66**

Hi-Impact Post

White (01), with gray rubber padding. Includes safety cap, tension strap, and Ground Sleeve.
66" **1-IP-66**

Flat Ground Sleeve

For Carsonite Original Post. Includes removable cap. Enables easy changeover to multiple configurations—soccer, baseball, volleyball, for example. **FGS401804U**

Package of 6 sleeves	FGS401804KIT
Replacement cap	FSC400

Ground Sleeve for FlexRod or Hi-Impact Post

Package of 6 sleeves	1-IGS-18KIT
Replacement cap	1-LSC-A

Corner Post

Adds rigidity to Carsonite Original Post Systems. . . . **CSFP06601**

Tools

Post Driver for Carsonite Original Flat Posts	RMTLPDR1
Post Driver for FlexRod Round Posts	RMTLDFROD
Pilot Hole Driver for rocky or hardpan soils	RMTLDP100
Post Puller for easy removal of any post style	RMTLCP

Replacement Parts

Reusable heavy duty fence ties (pack of 100)	FFFMRTYPK
Rope clips (pack of 85)	FFFMCLPK
3/16" x 170' Poly Rope for TuffNet fence	FFMR

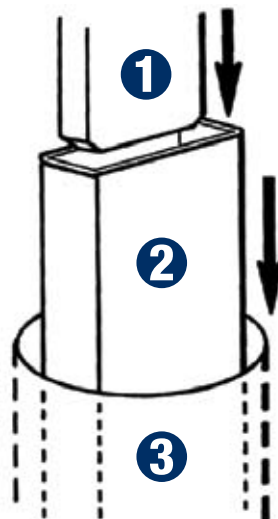

1. Carsonite Post
2. Ground Sleeve
3. Post Hole



Flexible safety Fencing

Fence Packages

TuffNet Mesh Fence Systems

Includes 4' roll of fencing, Fence Ties, Poly Rope, 6 Posts with safety caps and tension straps for each 50' of fence. Tools and Ground Sleeves, if needed, are available separately. Green, Orange, Red, or Blue.

With Carsonite Original Posts

50' Fence Kit	CRFM06601PK
100' Fence Kit	CRFM06601PKX100
150' Fence Kit	CRFM06601PKX150

With FlexRod Posts

50' Fence Kit	FRFM0106PK
100' Fence Kit	FRFM0112PK
150' Fence Kit	FRFM0118PK

With Hi-Impact Posts with Magnetic Ground Sleeves

50' Fence Kit	HIFM2906PK
100' Fence Kit	HIFM2912PK
150' Fence Kit	HIFM2918PK

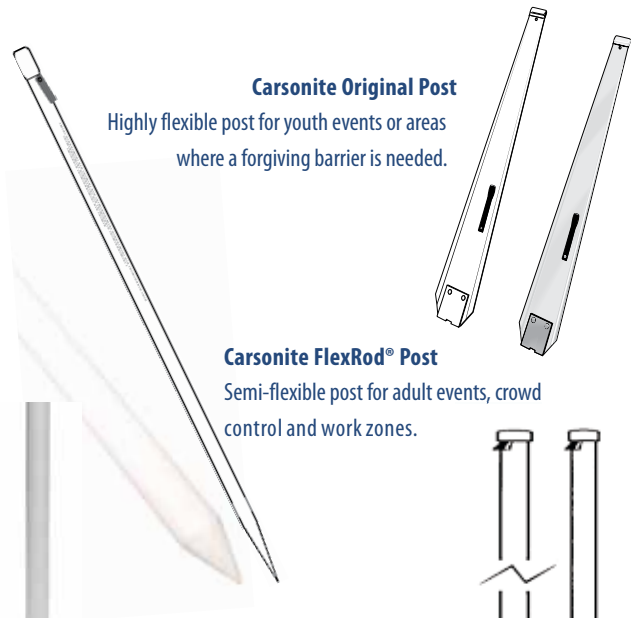

Carsonite Original Post

Highly flexible post for youth events or areas where a forgiving barrier is needed.

Carsonite FlexRod® Post

Semi-flexible post for adult events, crowd control and work zones.

Carsonite Hi-Impact Post

Offers 360-degree flexibility for both youth and adult events. Requires a Magnetic Locking Ground Sleeve for installation.

Ground Sleeves for FlexRod Posts remain in the ground and allow easy insertion and removal of fence posts. Ideal for applications where the fence will be taken down and put back up frequently.

Magnetic Locking Ground Sleeve

For use with FlexRod® and Hi-Impact Posts.

Special Locking Pin locks into the Magnetic Locking Ground Sleeve to reduce vandalism and tampering.

Rectangular Ground Sleeve

For use with Carsonite's Original Post. A cap excludes dirt and moisture when the sleeve is not in use.



ILLUSTRATIONS ARE NOT TO SCALE

Carsonite AcoustaShield™ Sound Barriers

How to Order:

Contact your representative or visit www.carsonite.com to request more information and an AcoustaShield information packet.

- ▶ Meets AASHTO and DOT sound wall guidelines
- ▶ Low maintenance over life of product
- ▶ Wide variety of colors available
- ▶ Spans up to 18 feet
- ▶ Graffiti resistant
- ▶ Lightweight, easily installed with minimal equipment
- ▶ Non-conductive fiberglass supports and panels

Effective against noise and light pollution

Carsonite's AcoustaShield Sound Barrier provides noise abatement along transportation corridors, as well as other applications requiring long-term outdoor durability, vandal resistance and ease of construction.

Easily customized, the system lets you design your sound barrier to fit your specific needs. Choose from unfilled, recycled-rubber filled, or absorptive options. These lightweight panels can be installed by a small crew without the use of heavy lifting equipment. The flame retardant panels can be easily cut in the field if on-site adjustments are needed. For applications under 15' in height, inquire about our fiberglass uprights.

Material: Fiberglass composite

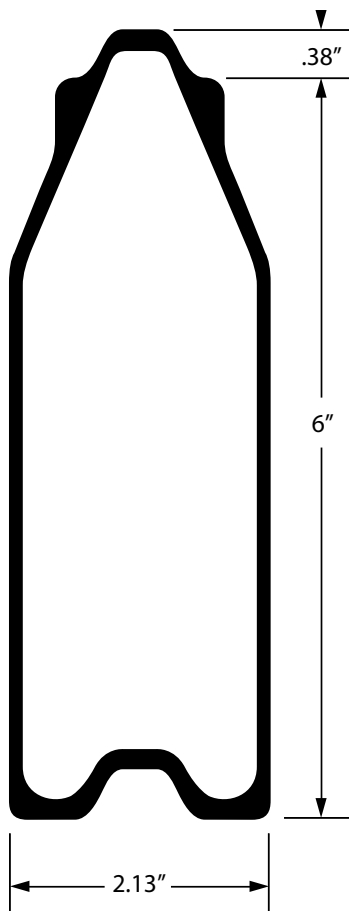

Acoustical Ratings			
	AcoustShield Absorptive	AcoustaShield Filled	AcoustaShield Unfilled
STC Rating	28	37	28
NRC Value	.95	.15	.20



At only 5 to 7 pounds per square foot, AcoustaShield does not add unnecessary weight to bridge structures.

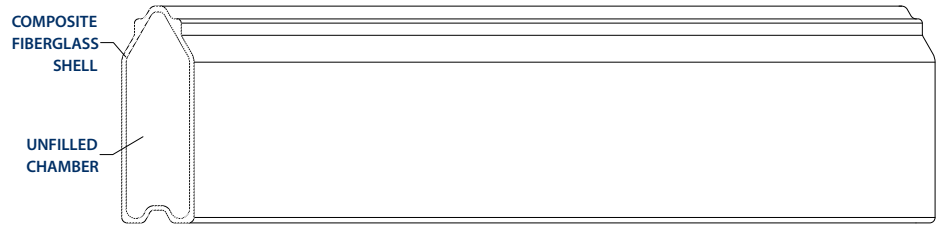

FIGURE 1 UNFILLED

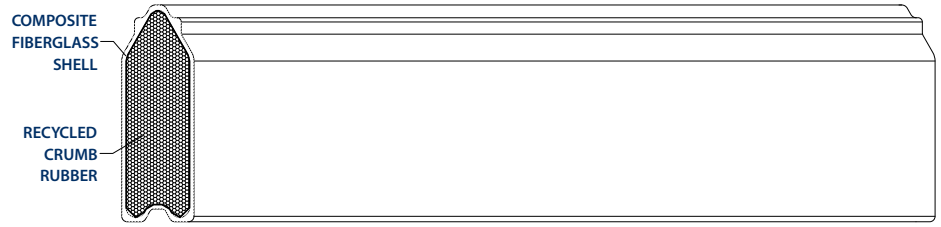

FIGURE 2 RUBBER FILLED

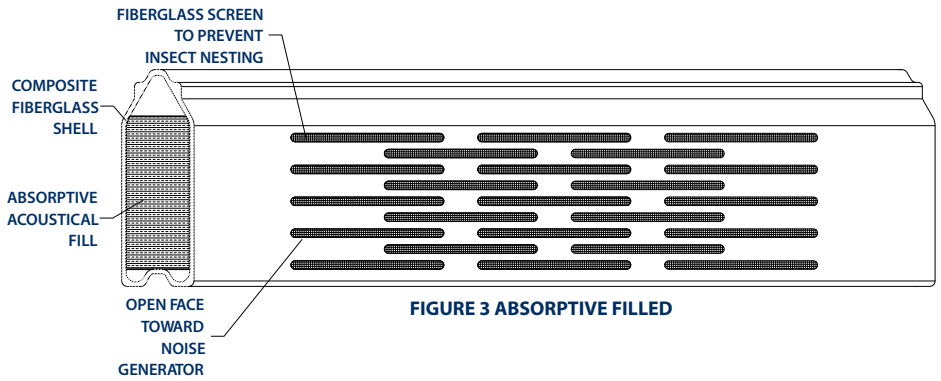

FIGURE 3 ABSORPTIVE FILLED



Carsonite AcoustaShield™ Sound Barriers



Carsonite sound barrier planks are adjustable and can be cut in the field.

A two-person crew can install 180 square feet in less than five minutes after uprights are set.





Installation Tools

How to Order:

Post Driver

R M T L

Product number

P D R 1

For Post Length
PDR1-5'-6'
PDL1-6'+
D400S-2'

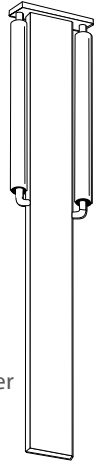

Guide Tube

R M T L P G T 1

Product number

Post Driver

FlexGuard Socket Driver

R M T L S M D 1 0

Product number

FlexGuard Socket Driver

Boundary Marker Driver

R M T L D 2 5 0

Product number

Boundary Marker Driver

Pilot Hole Driver

R M T L D P 1 0 0

Product number

Pilot Hole Driver

U-Channel Driver

R M T L D S D 3 0 0

Product number

U-Channel Driver

Post Puller

R M T L C P P

Product number

Post Puller

Material:

Welded Steel

For all soils and applications

Carsonite's Standard Post Driver (PDR1) is used to install RoadMarker,® Tuff-Flex™, Curv-Flex™, Dual-Sided Marker and GreenLine™ Single Curve Marker. 48" in length, this driver is for posts from 5 to 6 feet long.

Carsonite's Long Post Driver (PDL1) is used to install RoadMarker, Tuff-Flex, Curv-Flex, Dual-Sided Marker and GreenLine Single Curve Marker. At 56" in length, it is for posts over 6' long.

Carsonite's Short Post Driver (D400S) is used to install RoadMarker, Tuff-Flex, Curv-Flex, Dual-Sided Marker and GreenLine Single Curve Marker. At 24" in length, this driver is for posts under 5' long.

The FlexGuard Socket Driver (RMTLDSMD10) is for installing FlexGuard post sockets.

The Guide Tube (RMTLPGT1) gives an added assist in keeping posts vertical during installation. Also useful in preventing posts from flexing when installing into hard or rocky soil. The Guide Tube is useful with RMTLPDR1 or RMTLPDL1 drivers.

Boundary Marker Driver (RMTLD250). This accessory is intended for use with the Boundary Marker (CBM).

The U-Channel Driver (RMTLSDSD300) is intended for installing Carsonite's Curv-Flex or other Carsonite markers that utilize the U-Channel option.

The Pilot Hole Driver (RMTLDP100) is for use in hard or rocky soil when driving posts can be exceedingly difficult. The driver's spaded head leaves a hole to assist in driving the post. For use with all Carsonite markers.

Carsonite's Post Puller (RMTLCP) is used to remove posts that may need replacing. Use the Post Puller with any of our flat markers.

Other specialized tools are also available. Contact your representative.





ANCHOR BARBS

Protection from theft

Anchor barbs are intended to prevent the post from being pushed out of the ground during freeze/thaw cycles, as well as from attempts to pull them out by would-be vandals. Anchor barbs are available in polycarbonate. Purchase in packs of 10 or have them factory installed when ordering posts.



How to Order:

Composite Anchor Barb
(Installed at Factory)

ANCBARU

Product
number

Composite Anchor Barb
(loose, 10 pcs, including rivets)

ANCBARPK

Product
number

Notes



Horizontal lines for note-taking



<http://carsonite.com/recreation.asp>



19845 U.S. Highway 76
Newberry, South Carolina 29108
800-648-7916 · f/803-276-8940 · www.carsonite.com